



 **MORSE**
HARDWOODS & MILLWORK CO.



We hope you find this price list of our stair parts helpful and easy to use. While we ensure our milled products are the finest available, our commitment to serving you is our primary goal.

The Morse Hardwoods craftsmen are some of the finest in Vermont, and their work speaks for itself. Their dedication and skills have produced work found all over New England and New York since 1983. To keep pace, we're developing resources to provide our customers outlets they can learn more about the products we mill, and more about Morse Hardwoods and Millwork Company, in general.

That's why you can now find Morse Hardwoods on the internet, at www.morsehardwoods.com. We're excited about this site, and hope you'll discover what an incredible resource it is. Check out our current products and see what's new. Contact us with questions, or submit a request for a quote. We know this site will continue to grow as an asset to all our customers.

From printed catalogs you can throw on the dash, to our moulding profile CD-ROMs you can slip into any computer, we're dedicated to providing a variety of resources, just as we are dedicated to milling a variety of products. Inside the Morse Hardwoods Mill, we keep a fully equipped wood shop-with moulding capabilities and a fully optimized cutting line - running with orders for flooring, mouldings, dimension lumber and more. From astragal to wainscot, our guys are pros, and our process is proven. Whether you need something from our stock, or are interested in custom designs, we're ready to get your order underway.

Sincerely,

Brad Morse

Brad Morse

Scott Morse

Scott Morse

TABLE OF CONTENTS



Signature Series



Classic Series



Designer Series



Hampton Series



Traditional Series



Traditional Series



Contemporary Series



Wrought Iron Series

Signature Series	2-3
Classic Series	4
Designer Series	5
Hampton Series	6
Traditional Series	7-8
Contemporary Series	9
Wrought Iron Series	10
Handrail	11
Fittings	12-13
Treads	14
Accessories	15
Stair Parts Guide	16

SIGNATURE series

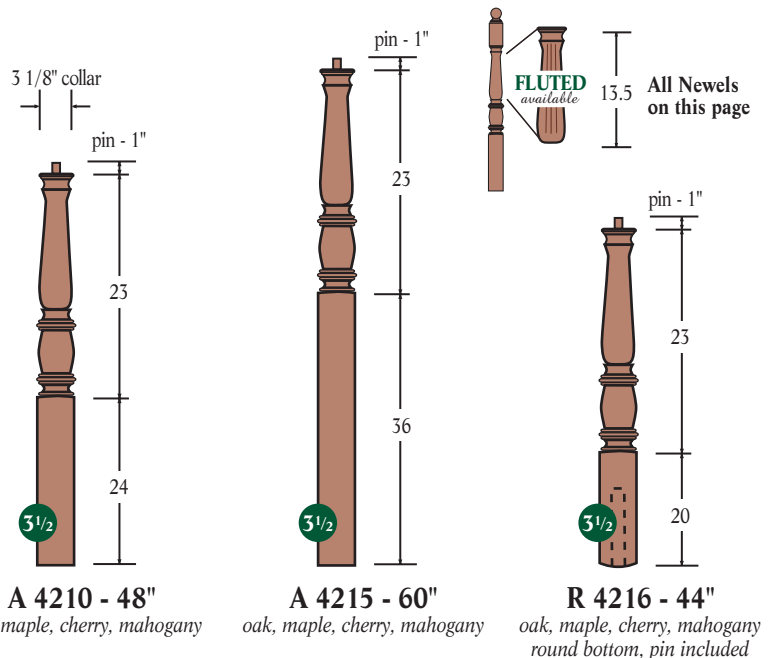
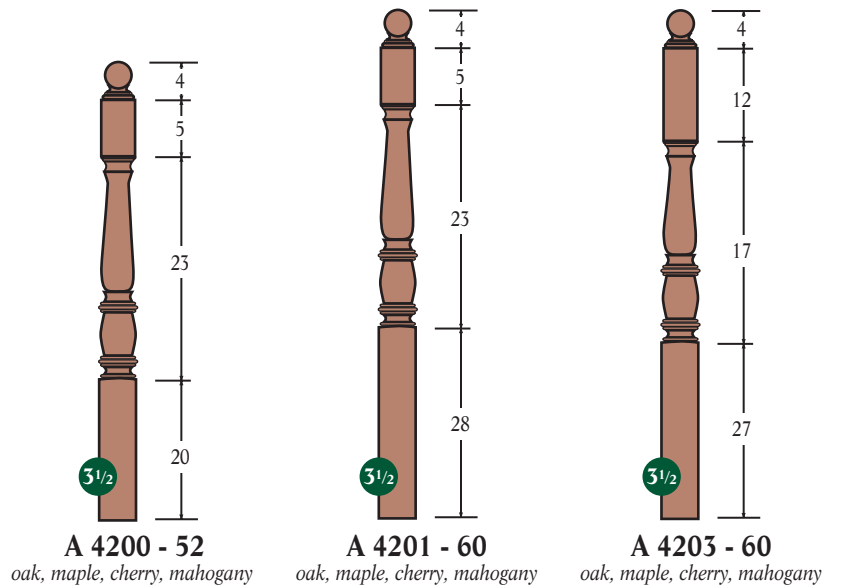
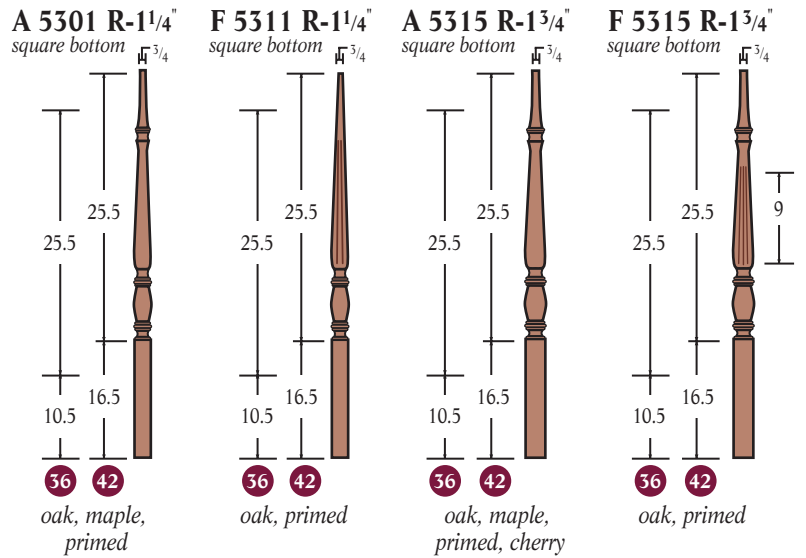

Handrail Profile Choices



SIGNATURE series

A 5325 S - 1 3/4"

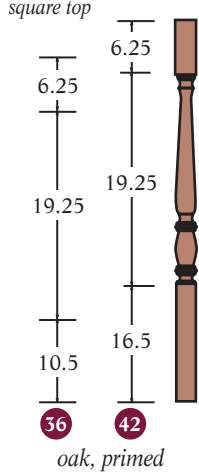

R 5315 R - 1 3/4"

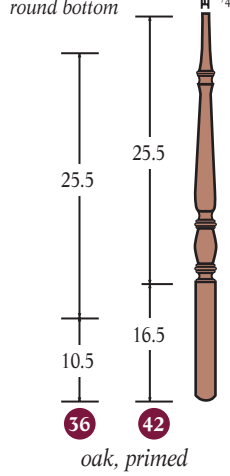

O 5315 R - 1 3/4"

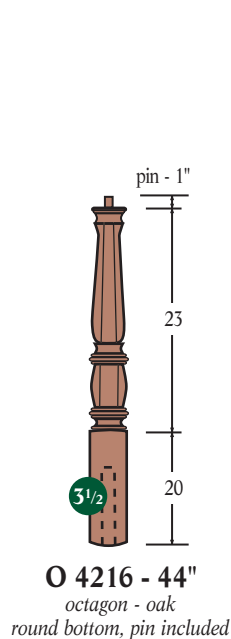
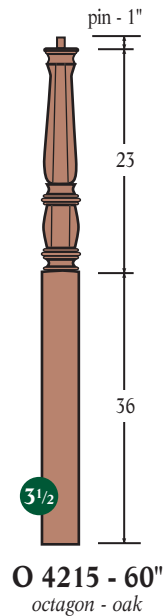
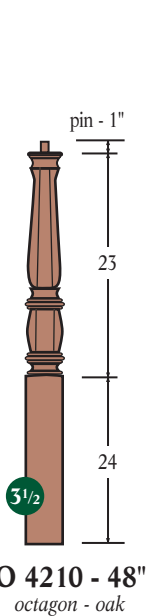
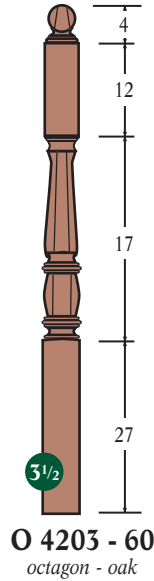
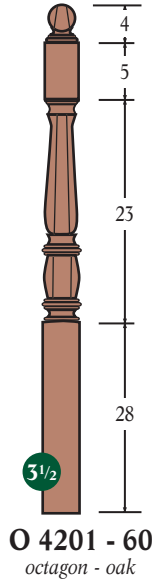
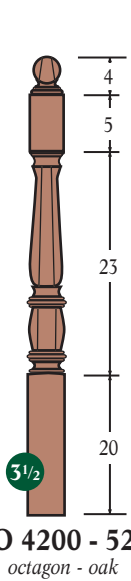
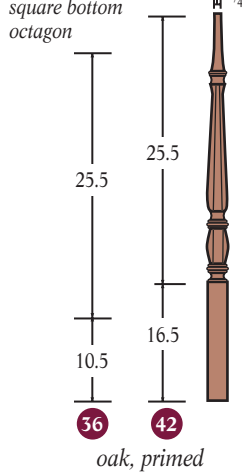

Handrail Profile Choices

- | | | | |
|---------------------------------------|-----------------------------|---|---|
| | | | |
| 6010
oak
maple
cherry | 6210
oak
maple | 6510
oak
maple
cherry
mahogany | 6710
oak
maple
cherry
mahogany |

CLASSIC series



A 5215 R - 1 3/4" square bottom

F 5215 R - 1 3/4" square bottom, fluted

A 5225 S - 1 3/4" square bottom

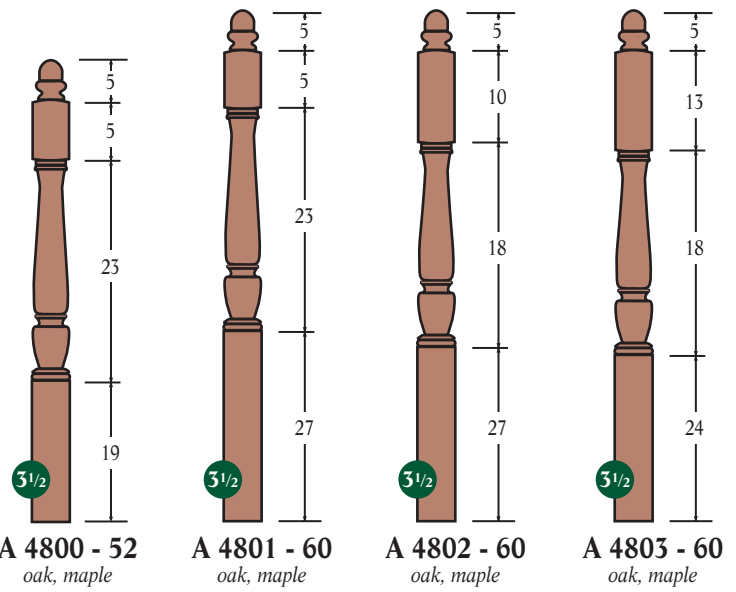
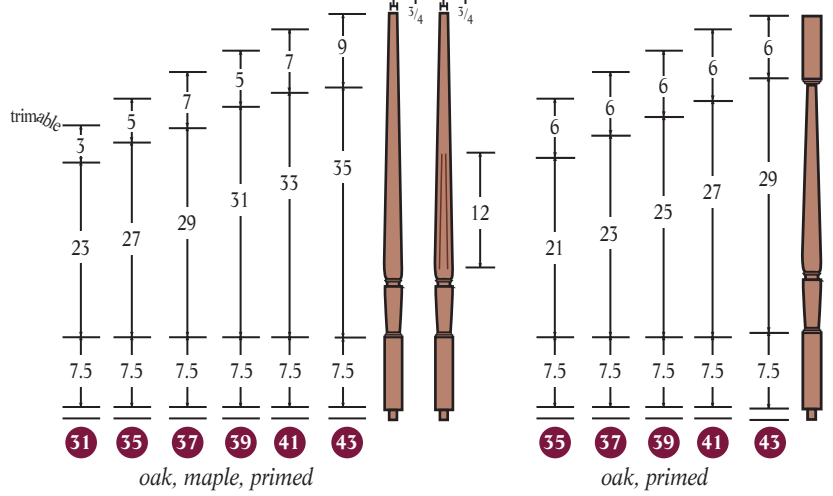

A 4800 - 52 oak, maple; A 4801 - 60 oak, maple; A 4802 - 60 oak, maple; A 4803 - 60 oak, maple

Handrail Profile Choices

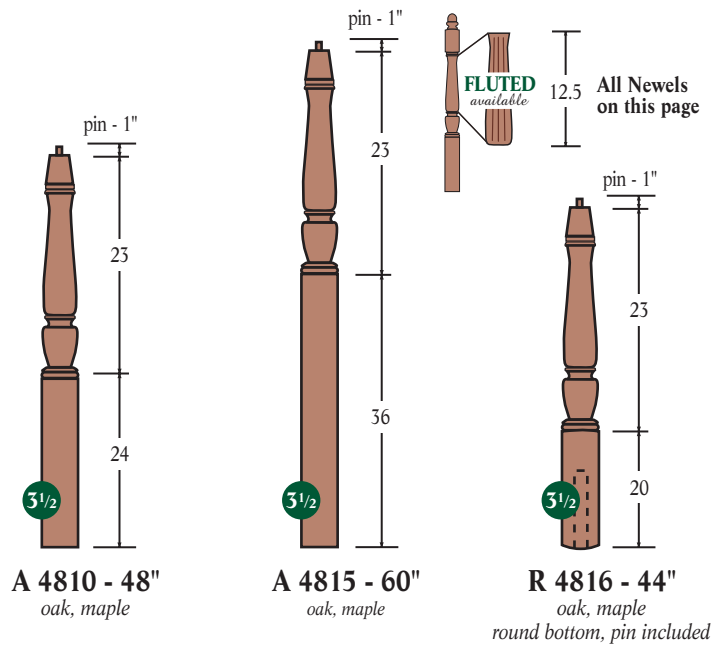
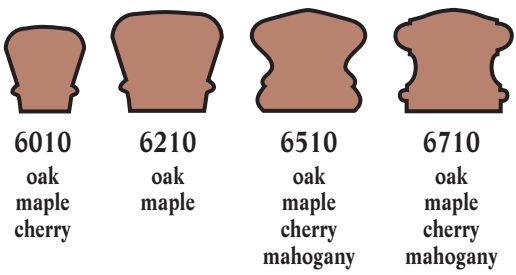

A 4810 - 48" oak, maple; A 4815 - 60" oak, maple; R 4816 - 44" oak, maple round bottom, pin included

A 5515 R, T 5515 R, F 5515 R - 1 3/4"

square bottom
standard, twist or fluted

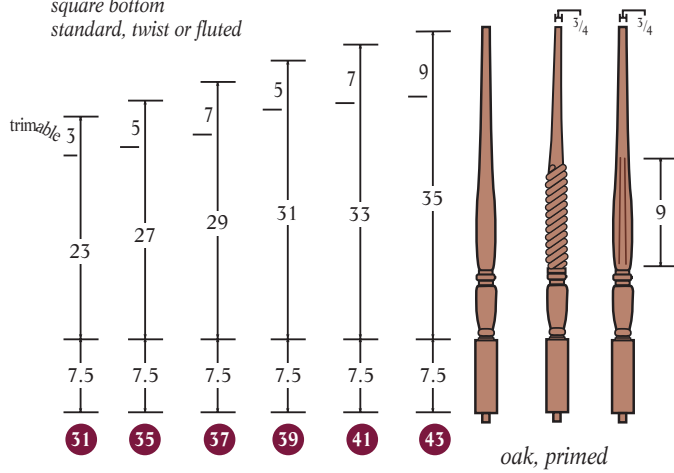

A 5415 R - 1 3/4"

square bottom

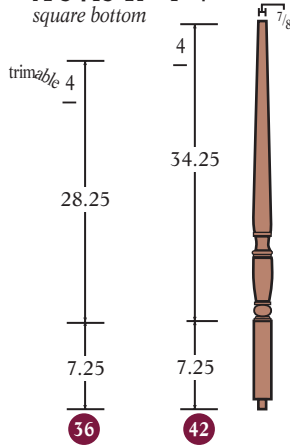

oak, primed, cherry

F 5415 R - 1 3/4"

square bottom

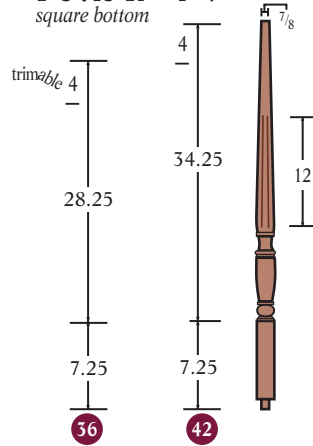

oak, primed, cherry

bottom pin is 7/8" in diameter and 1/2" long

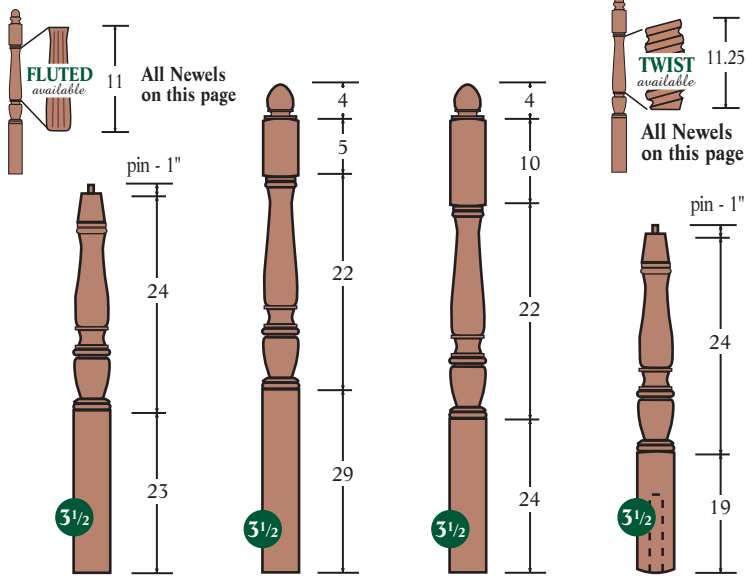

A 4410 - 48
oak, cherry, mahogany

A 4401-52/60
oak, cherry, mahogany

A 4402 - 60
oak, cherry, mahogany

R 4416 - 44
oak, cherry, mahogany
round bottom, pin included

Handrail Profile Choices

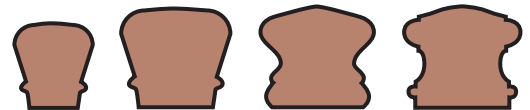

6010
oak
maple
cherry

6210
oak
maple

6510
oak
maple
cherry
mahogany

6710
oak
maple
cherry
mahogany

HAMPTON series



A 5200 R - 1 1/4"
square bottom

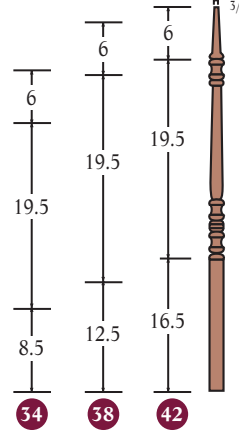

oak, primed

A 5611 R - 1 3/4"
square bottom

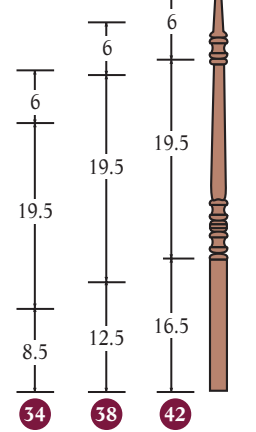

oak, primed

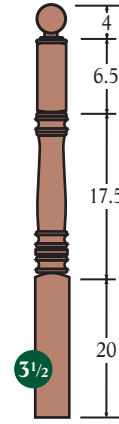

A 4500- 48
oak, maple

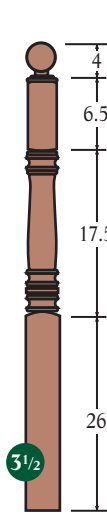

A 4501- 54
oak, maple

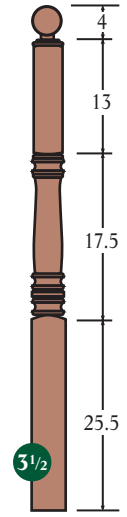

A 4503- 60
oak, maple

Handrail Profile Choices



A 5005 S - 1 3/4"
square bottom
square top

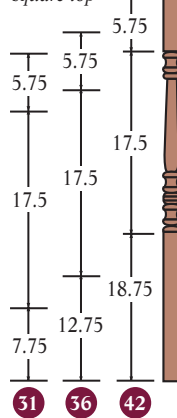

A 5005 S
oak,
hemlock, primed

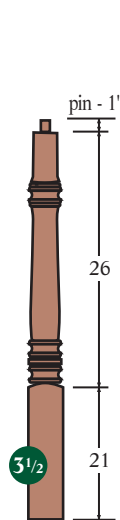

A 4510 - 48
oak, maple

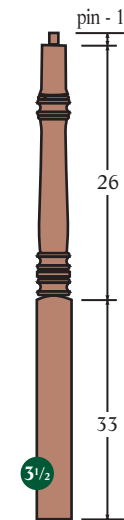

A 4515 - 60
oak, maple

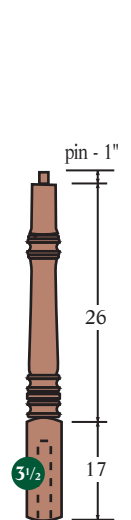

R 4516 - 44
oak, maple
round bottom, pin included

TRADITIONAL series

A5015

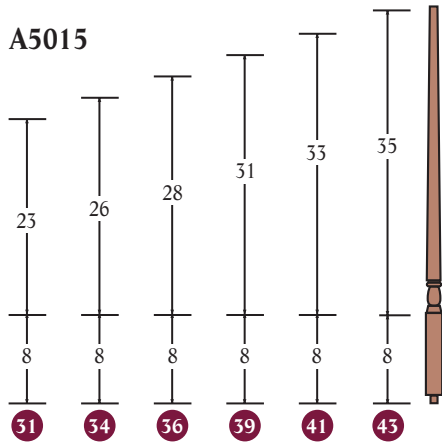

oak, maple, poplar, primed

5015B - 1 1/8" - 5/8" top

5015C - 1 1/4" - 5/8" top

5015S - 1 1/4" - 3/4" top

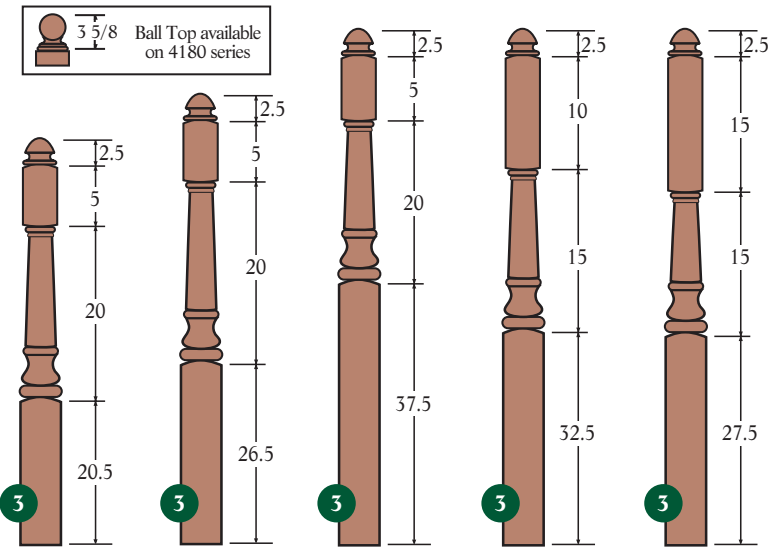
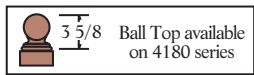

A4180-48/52 oak, poplar, maple square bottom
A4181-54 oak, poplar, maple square bottom
A4182-60,72 oak, poplar, maple square bottom
A4183-60 oak, poplar, maple square bottom
A4184-60 oak, poplar, maple square bottom

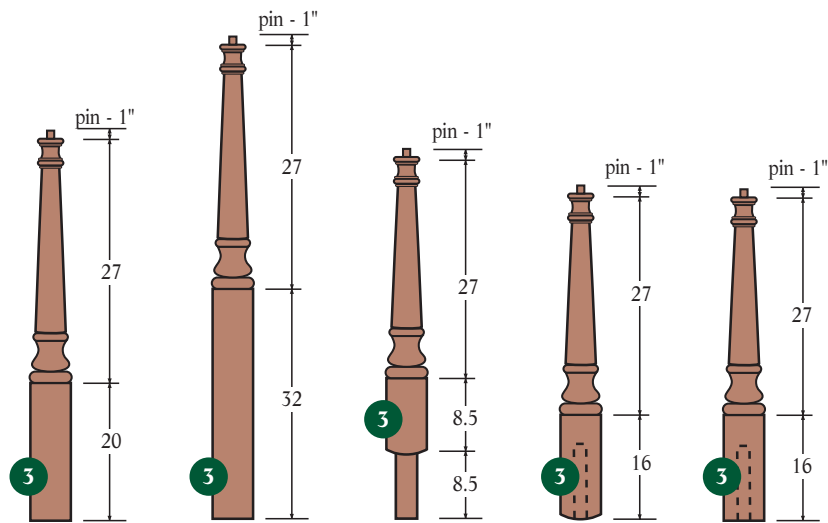

A 4010 - 48 oak/poplar/maple
A 4015-60/72 oak/poplar/maple
R 4012 - 45 oak round bottom
R 4016 - 44 oak/maple round bottom, pin included
S 4016 - 44 oak/maple square bottom pin included

Handrail Profile Choices



TRADITIONAL series



A 5070 S - 1 1/4"
square top

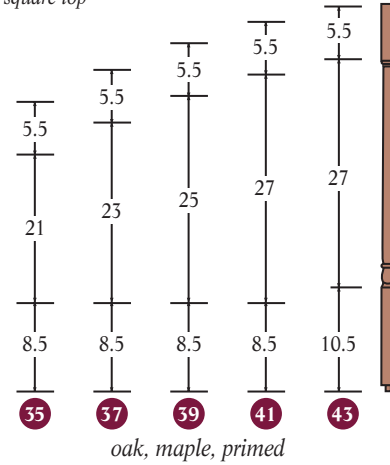

Ball Top available on 4040 series

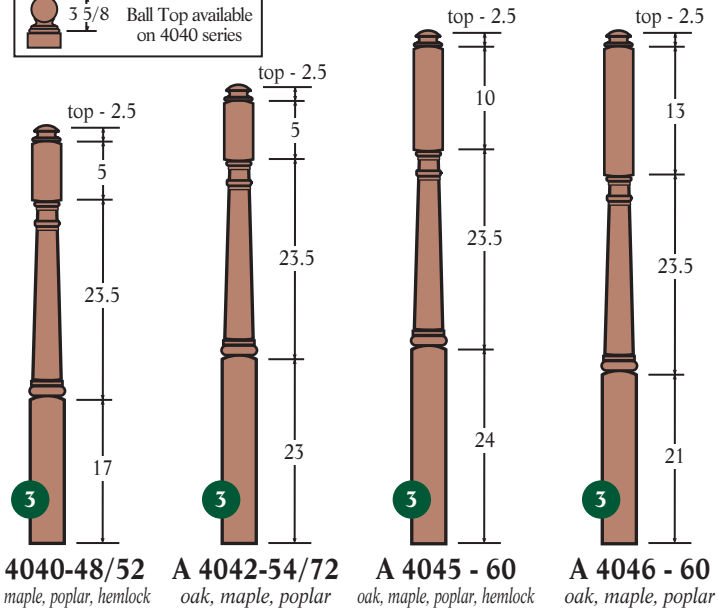

Note: oak, maple and hemlock also available with ball top

Handrail Profile Choices

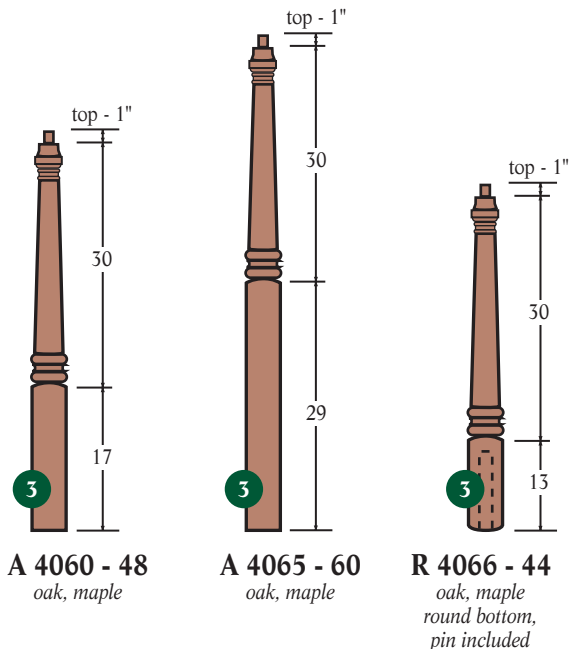

A 5060 - 1 1/4"

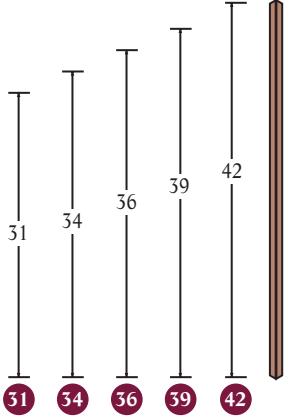

oak, poplar, maple, primed

A 5360 - 1 3/4"

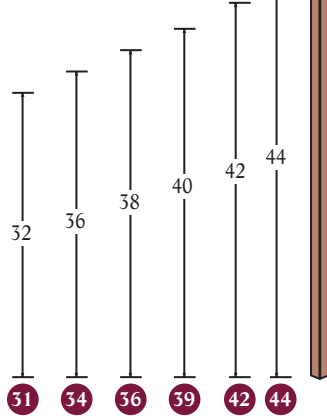

oak, poplar, maple, cherry, primed available

Newel Squares also available
oak, maple, poplar, hemlock, cherry, mahogany

A 5040 - 1 1/8" finished

5/8 top standard

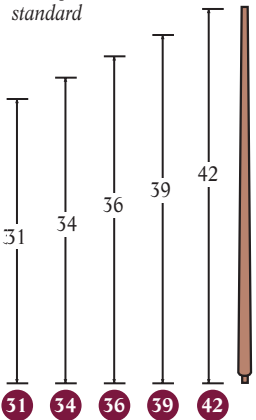

oak, poplar primed

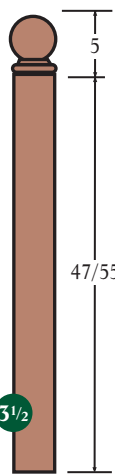

A 4005 - 52/60
oak, poplar

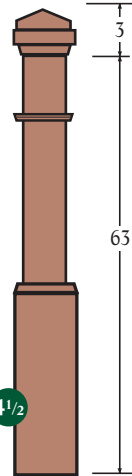

A 4075 - 66
oak, maple, primed, cherry
bottom sleeve removable

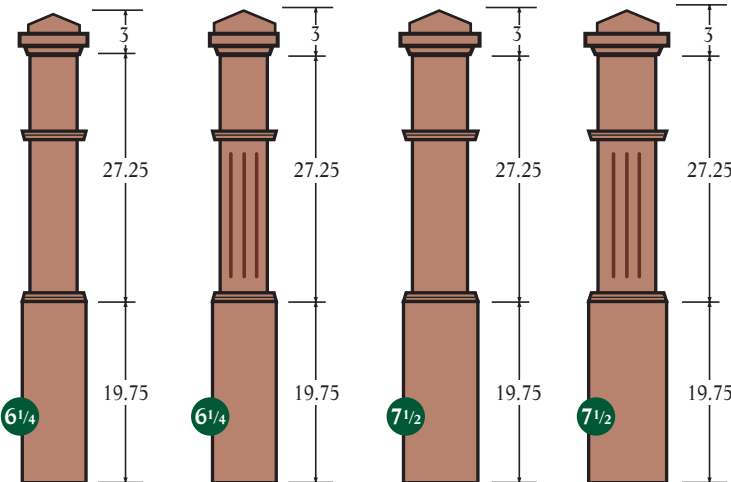

A 4071 - 55
oak, maple, cherry, primed

F 4071 - 55
oak, maple, cherry

A 4271 - 55
oak

F 4271 - 55
oak

Handrail Profile Choices



FORGED IRON

series

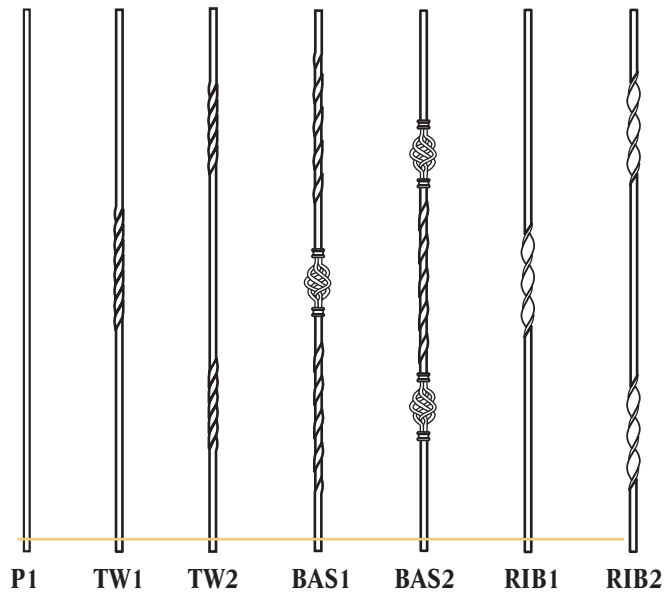

Finishes Available



powder coat



black

- Black & powder coated finishes available
- All balusters are:
 - 1/2" x 1/2"
 - 44" length with details centered 18" from top
 - rounded to 1/2" diameter on top 3/4" for easy installation
- Butterfly is 6" wide x 4" tall
- Scroll is 7 1/2" wide x 24" tall
- Baskets are 2 1/2" wide x 4" tall

Handrail Profile Choices

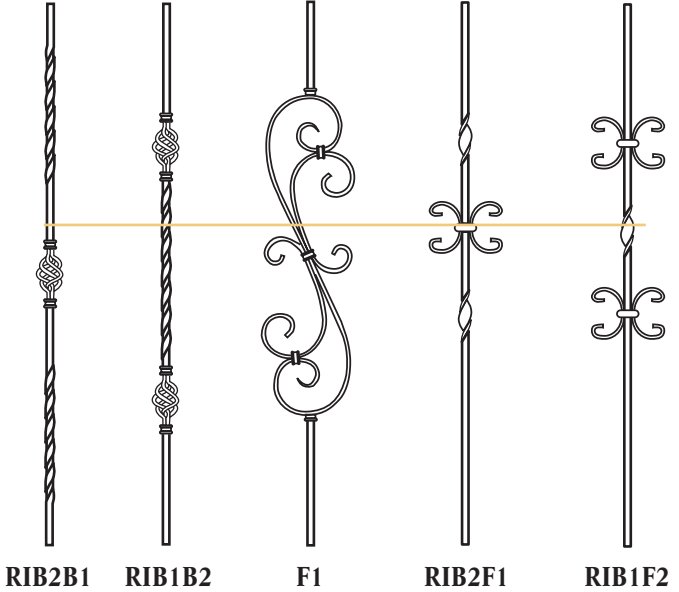

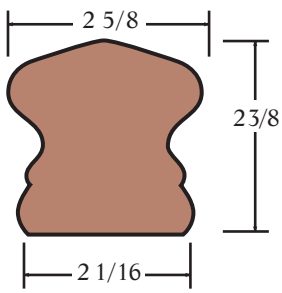

6510 E

- 12'-16' may have one seam joint in top ply

Oak, Maple,
Cherry, Mahogany

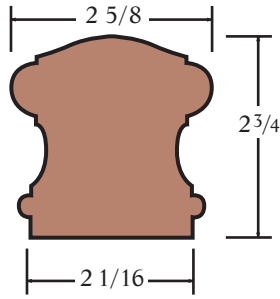

6710 E

- 12'-16' may have one seam joint in top ply

Oak, Maple,
Cherry, Mahogany

*All Northern Red Oak
Excellent Color Match*

*We will make every attempt to supply your
specified hand rail lengths,
but you may receive the next available length,
and in those cases you will be charged
for the length shipped.*

All Profiles and Species Available in Bending Rail

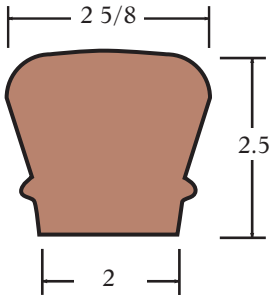

6210 E

- 12', 14' & 16' with one seam joint in top cap

Oak, Maple

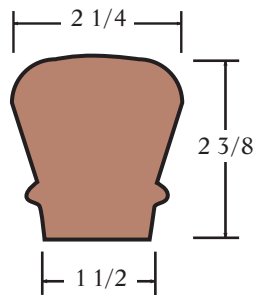

6010 E

- 12', 14', 16' & 18' with one seam joint in top cap

Oak, Maple, Cherry

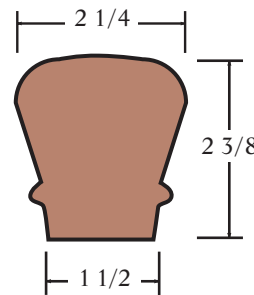

6010 AS

- Sold as random lengths
- 11.5 - 16' may have one finger joint in each ply

Oak

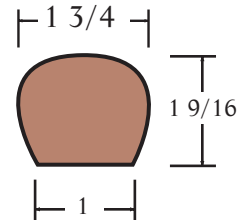

6040

- Constructed with all plys containing fingerjoints
- 16' lengths only

Oak, Maple

Shoe Rail

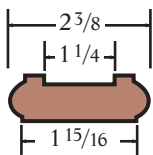

6045

1 1/4 x LF
oak, maple

Fillet



6055

1 1/4 x LF
oak, maple

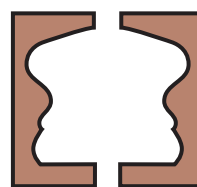

6510

pine molding

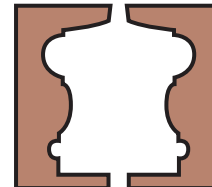

6710

pine, plastic molding

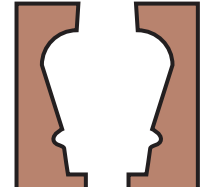

6010/6210

pine molding

Shoe Rail

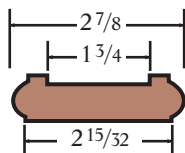

6006

1 3/4 x LF
oak, maple

Fillet



6007

1 3/4 x LF
oak, maple,
cherry, mahogany

E - Engineered Rail:
Superior Color and Stability

FITTINGS



7008
Oak



Return
End

7009 **7709**
O-M-C O-M-C-MG
7209 **7509**
O-M O-M-C-MG

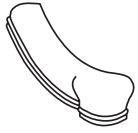

Starting
Easing w/ cap

7010 **7710**
O-M-C O-M-C-MG
7210 **7510**
O-M O-M-C-MG



Level
Quarter Turn

7011 **7711**
O-M-C O-M-C-MG
7211 **7511**
O-M O-M-C-MG



135°
Level
Quarter Turn

7011-135° **7711-135°**
O-M-C O-M-C-MG
7211-135° **7511-135°**
O-M O-M-C-MG



Up
Easing

7012 **7712**
O-M-C O-M-C-MG
7212 **7512**
O-M O-M-C-MG



Over
Easing

7013 **7713**
O-M-C O-M-C-MG
7213 **7513**
O-M O-M-C-MG



90° Up
Easing

7014 **7714**
O-M-C O-M-C-MG
7214 **7514**
O-M O-M-C-MG

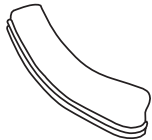

Starting
Easing w/
return end

7015
oak



Over
Easing w/
return end

7016
oak



Opening
Cap

7019 **7719**
O-M-C O-M-C-MG
7219 **7519**
O-M O-M-C-MG

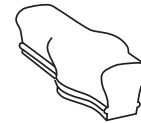

Tandem
Cap

7020 **7720**
O-M-C O-M-C-MG
7220 **7520**
O-M O-M-C-MG

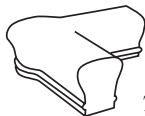

Quarter
Turn Cap

7021 **7721**
O-M-C O-M-C-MG
7221 **7521**
O-M O-M-C-MG

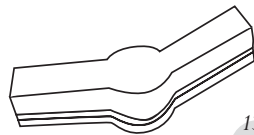

135°
Level Quarter
Turn Cap

7021-135° **7521-135°**
O-M-C O-M-C-MG
7221-135° **7721-135°**
O-M O-M-C-MG



"S"
fitting
left/right
5" C-2-C

7047/48
O-M-C
7247/48
O-M
7547/48
O-M-C-MG
7747/48
O-M-C-MG

FITTINGS

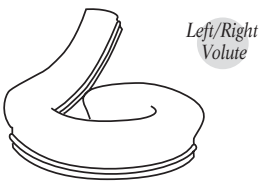

Left/Right
Volute

7030/35 **7730/35**
O-M-C O-M-C-MG
7230/35 **7530/35**
O-M O-M-C-MG

4 3/4 center to center



Left/Right
Climbing Volute

7031/36 **7731/36**
O-M-C O-M-C-MG
7231/36 **7531/36**
O-M-C-MG O-M-C-MG

4 3/4 center to center



Left/Right
Turnout **7041/46**
oak

2 7/8 center to center

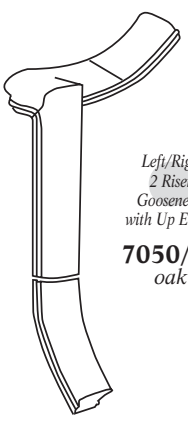

Left/Right
2 Riser
Goosenecks
with Up Easing

7050/55
oak

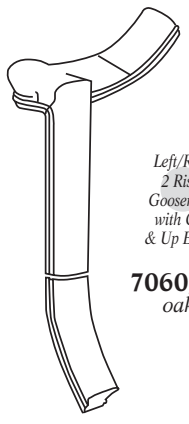

Left/Right
2 Riser
Goosenecks
with Cap
& Up Easing

7060/65
oak

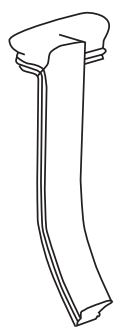

Left/Right
1 Riser
Gooseneck

7070/75
oak



Left/Right
Turnout

7040/45 **7740/45**
O-M-C O-M-C-MG
7240/45 **7540/45**
O-M O-M-C-MG
3 1/2 center to center

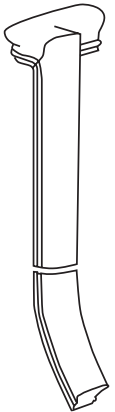

Left/Right
2 Riser
Goosenecks

7071/76 **7771/76**
O-M-C O-M-C-MG
7271/76 **7571/76**
O-M O-M-C-MG



Left/Right
1 Riser
Goosenecks
with cap

7080/85
oak

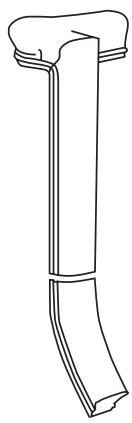

Left/Right
2 Riser
Goosenecks
w/ cap

7081/86 **7781/86**
O-M-C O-M-C-MG
7281/86 **7581/86**
O-M O-M-C-MG

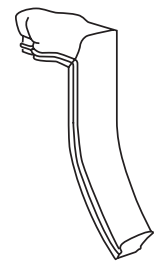

Straight
1 Riser
Gooseneck
w/ tandem
cap

7088
oak

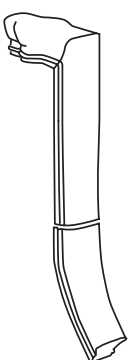

Straight
2 Riser
Gooseneck
w/ tandem
cap

7089 **7789**
O-M-C O-M-C-MG
7289 **7589**
O-M O-M-C-MG

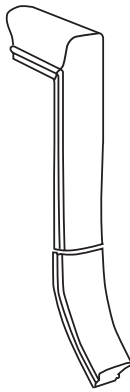

Straight
2 Riser
Gooseneck

7099 **7799**
O-M-C O-M-C-MG
7299 **7599**
O-M O-M-C-MG

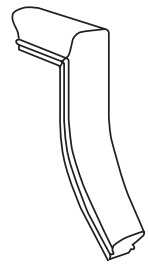

Straight
1 Riser
Gooseneck

7098
oak

STAIR TREADS & STARTING STEPS

E - Engineered Treads:
Superior Color and Stability

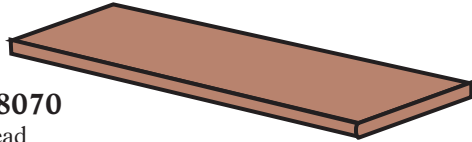

E 8070
Tread
1 1/32" x 10 1/2"
x 36, 42, 48, 54, 60, 72
Oak

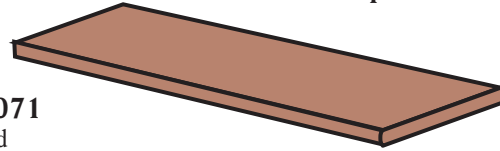

E 8071
Tread
1 1/32" x 11 1/2"
x 36, 42, 48, 54, 60, 72
Oak, Maple, Cherry

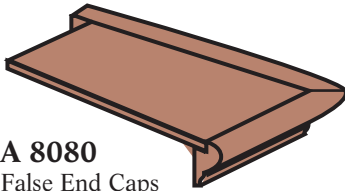

A 8080
False End Caps
Oak

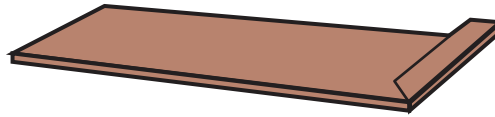

E 8070 MR - 10 1/4"
E 8071 MR - 11 1/4"
Oak Mitered Return Tread
1 1/32" x 10 1/4" or 11 1/4"
x 48, 60, 72
Oak, Maple, Cherry

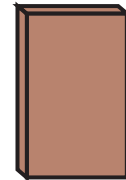

A 8085
False Riser
Oak

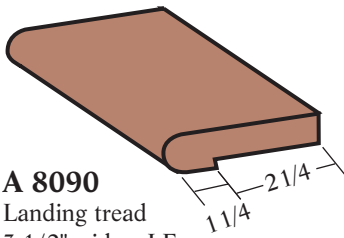

A 8090
Landing tread
3 1/2" wide x LF
Oak, Maple, Cherry



E 8075
Riser
3/4" x 8"
x 42, 48, 60, 72
Oak, Maple, Cherry, Primed

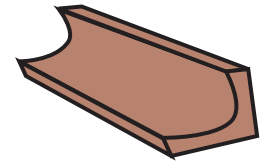

A 8095
Cove Mould
3/4" x 3/4" x LF
Oak, Maple, Cherry

A 8091
Landing tread
5 1/4" wide x LF
Oak, Maple, Cherry

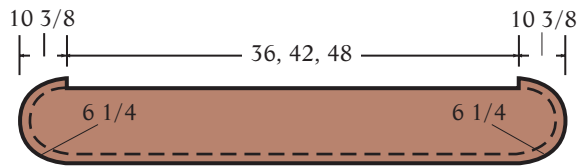

A 8015
Double starting step
Oak, Oak with primed riser 48" only

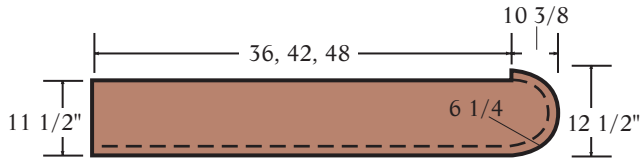

A 8010 R/L
Reversible starting step
Oak, Oak with primed riser 48" only

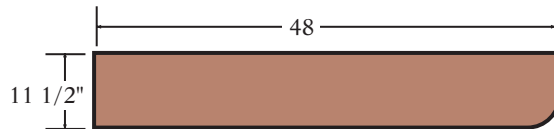

A 8040
Oak

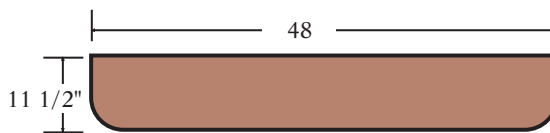

A 8060
Oak

ACCESSORIES

3010
Iron Epoxy
Conversion Kit

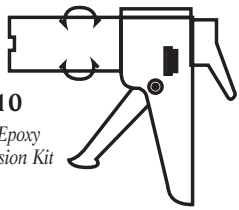

3009
Iron Epoxy
Nozzle



3011
Iron Epoxy

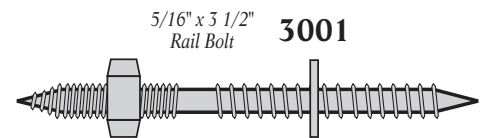
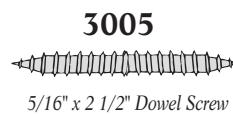
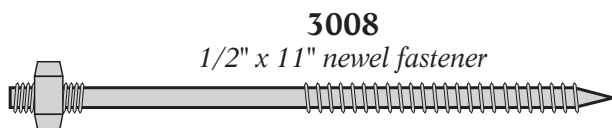
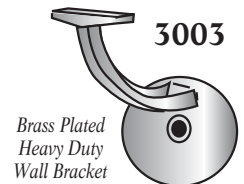
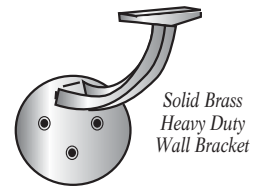
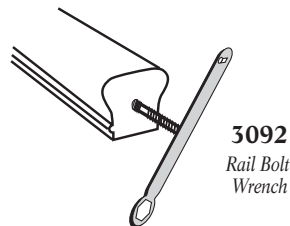
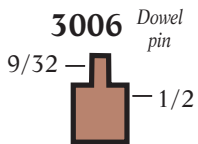
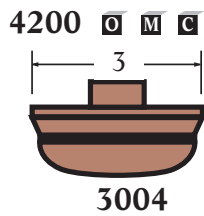
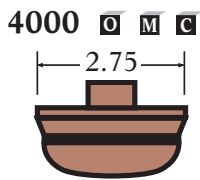
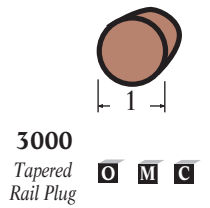
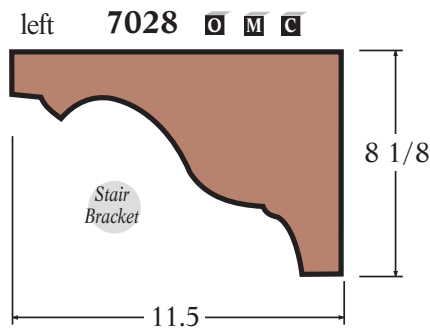
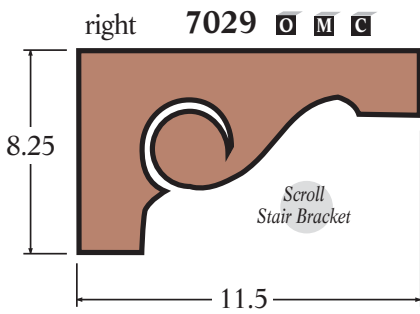
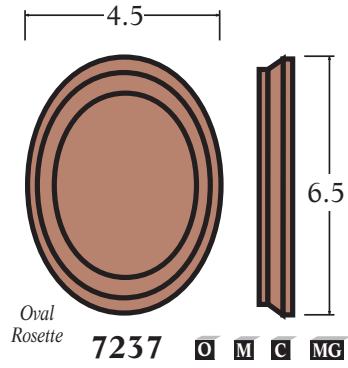
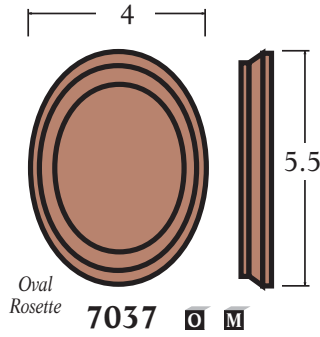
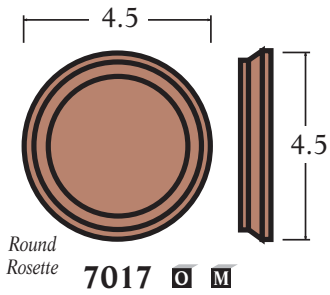

STAIR PARTS. GUIDE

Traditional Applications

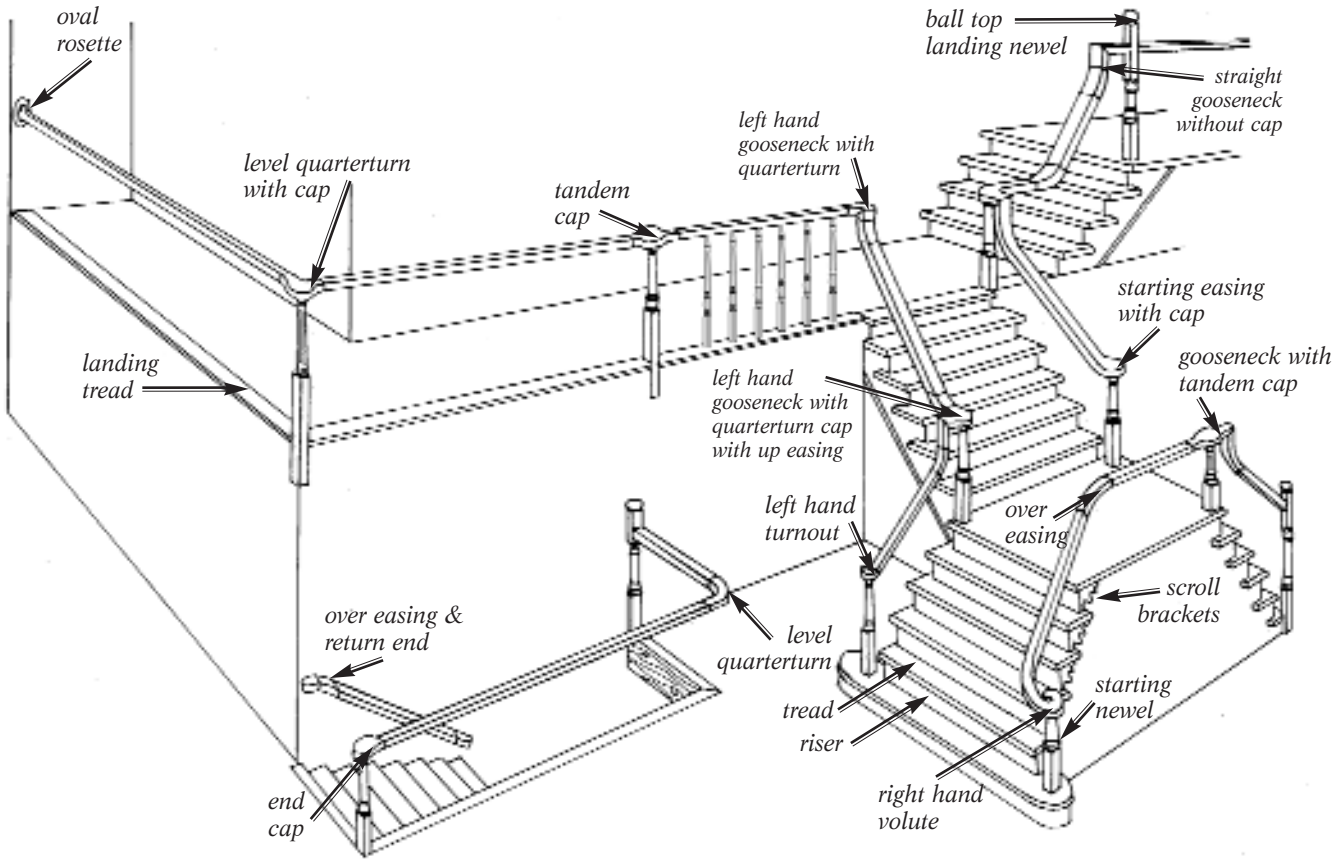
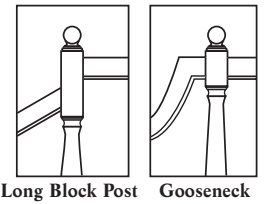

Recommended Baluster Lengths for Various Rake Handrail Heights

30" Handrail Height

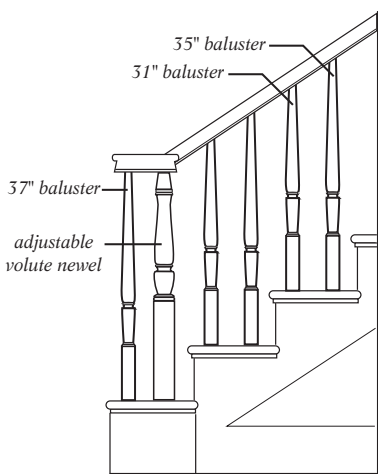

34" Handrail Height

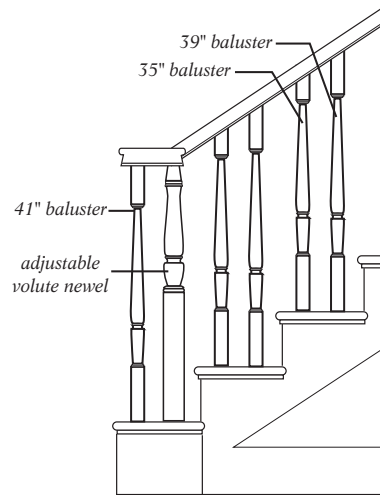

36" Handrail Height

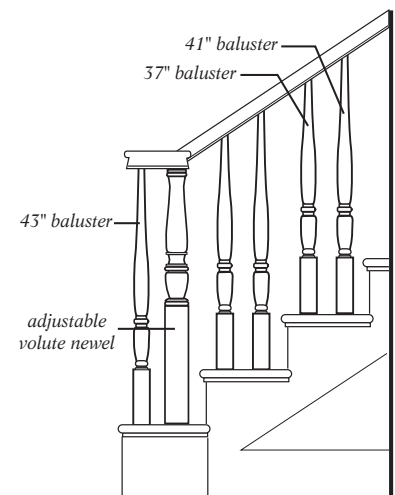

Based on a rise of 7 1/2" and a run of 10"



POLICIES:

Morse Hardwoods and Millwork Company shall not be responsible for improper use or misuse of its products and offers no warranty for safety or performance. Morse Hardwoods and Millwork Company conditionally guarantees its products to be free from defective material and/or workmanship within its control for a period of one year. All stair parts are for interior use only. Rotate inventory to reduce exposure and care should be used in storing these products. Installation of these stair parts should be made from a qualified installer according to local or appropriate building codes. These codes should be strictly observed and use only the best and safest practices when installing these stair parts.

TERMS:

1% 10 Days, Net 15 Days.

A 2% per month finance charge will be applied to all past due balances.

Send payments to: Morse Hardwoods and Millwork Company 20 Morse Drive • Essex Junction, Vermont 05452

PRICES:

All prices are subject to change without notice.

SHIPMENTS:

All orders will be processed for shipment from our warehouse. All claims on apparent or concealed shipping damage should be reported to the freight line for settlement of claim.

RETURNS:

- Standard items may be returned only with prior approval by
- Merchandise must be in original cartons and in good, original condition. Morse Hardwoods and Millwork Company and will be charged
- Original invoice numbers must be indicated on all returns. 25% of the sale price to cover re-stocking and handling.
- Returns should be sent pre-paid freight within 90 days of purchase.

SPECIAL ORDERS:

A 50% deposit is required on all special orders before processing and production of the order. Once production has started the order cannot be cancelled.

INTERIOR USE:

All products are only to be used for interior use.

HALF NEWELS:

Half newels are available at 75% of the price of full newels. Box newels are not available as half newels.

HEARTWOOD/SAPWOOD:

When we establish a Sales Price for stock or custom parts, we anticipate using heart and sapwood.

HANDRAIL LENGTHS:

We will make every effort to supply your specified hand rail lengths, but you may receive the next available length, and in those cases you will be charged for the length shipped.



 **MORSE**
HARDWOODS & MILLWORK CO.

20 Morse Drive
Essex Junction, Vermont 05452
phone...802-878-2061 • fax...802-878-7215
toll free...1-800-321-4112
www.morsehardwoods.com